

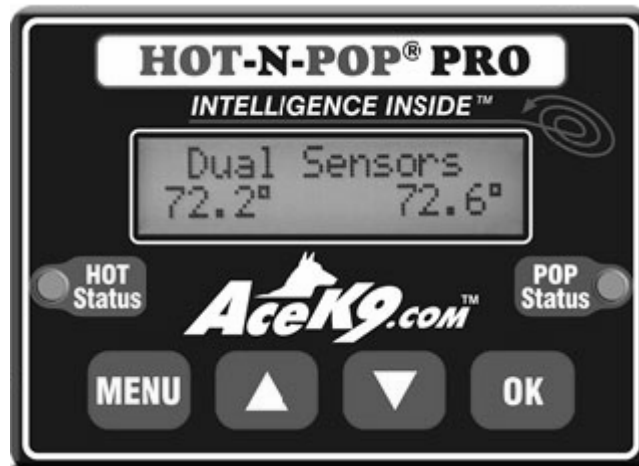

Model HP-5010



Patent # 7,081,811

## Hot-N-Pop® Pro Installation Manual

Radiotronics Inc.  
1315 SW Commerce Way  
Stuart FL 34997  
Phone: (772) 600-7574  
Fax (772) 600-7012

## Introduction

Hot-N-Pop® Pro combines all the features of K9 Heat Alarm® Pro and K9 Door Popper®. The Door Popper features a system that prevents the door from opening while the vehicle is in gear. Our exclusive double pop system unlocks the K9 door and releases the latch when the K9 Popper is activated. The Heat Alarm includes our vehicle monitoring system and Alert Options: S.O.S. Sound Horn Activation, Dual Window Drop, Emergency Light Activation, and Siren Activation.

### **HP-5010 Standard Parts**

- 1 - Intelabox**
- 1 - Control Head**
- 1 - Control Head Cable**
- 1 - Owners & Install**
- 1 - Vehicle Specific Instructions\***
- 1 - Installation Hardware Kit**
  
- K9 Door Popper
  - 1 - Gas Spring**
  - 1 - Solenoid**
  - 1 - Bead Chain** (not required no some vehicles)
  - 1 - Cable Kit**
  - 1 - Antenna**
  
- K9 Heat Alarm
  - 2 - Temperature Sensor**
  - 1 - Options Cable**
  - 1 - Light Activation Module**
  - 1 - Window Drop Module**

### **Standard Outputs**

- Door Popper
  - 1 - Solenoid**
  - 1 - Unlock**
  
- Standard Heat Alarm Outputs
  - 1 - Horn Activation**
  - 1 - Siren Activation**
  - 1 - Light Activation**
  - 1 - Window Drop Activation**

### **Outputs for Optional Accessories (Purchased separately)**

- 1 - Pager Activation**
  - 1 - Fan Activation**
  - 1 - Auto Starter Activation**
- For Aftermarket Auto Starters

### **Inputs for Optional Detectors**

- 1 - No K9 Left Behind**
- 1 - Stall Sensor** (included with auto start activation)

Accessory Connector

- 1 - 3 Pin "Daisy Chain Connector"**
- For additional Accessories

## Contents

Warnings and Safety information	Page 3	STEP 13 Optional Modules	Page 7
STEP 1 Install info	Page 4	STEP 14 Heat Alarm Test	Page 7
STEP 2 Control Head	Page 4	<b>Door Popper steps</b>	Page 8
STEP 3 Intelabox	Page 4	STEP 15 Neutral Safety	Page 8
STEP 4 Main Power	Page 4	STEP 16 Antenna	Page 8
STEP 5 Options Cable	Page 4	STEP 17 Door Prep	Page 8
STEP 6 Horn feature	Page 5	STEP 18 Door Wires	Page 8
STEP 7 Siren feature	Page 5	STEP 19 Wire connection	Page 8
STEP 8 Light feature	Page 5	STEP 20 Solenoid installation	Page 9
STEP 9 Window drop	Page 6	STEP 21 Gas Spring	Page 10
STEP 10 Temp. Sensors	Page 6	STEP 22 Testing	Page 11
STEP 11 Ignition power	Page 6		
STEP 12 Stall Sensor option	Page 7		

## Safety Warnings and Installation Information

### ***Read these instructions and the vehicle supplement.***

*It is the responsibility of the Installer to Read these instructions, warnings, and confirm that all safety features are installed, tested and working properly at the time of installation.*

Refer to the vehicles service manual and modifiers guides during installation.  
Do not install equipment in areas that interfere with vehicles safety systems like airbags.  
Use Caution to avoid damage to wiring, fuel lines, or other equipment.

Never run wires through a drilled hole without a grommet, the wire can become chaffed cause malfunctions or vehicle fire. Seal gromets to prevent water entry into vehicle.

Connectors exposed to moisture should be protected.

As the installer of emergency equipment, proper installation techniques are your responsibility!

---

### **Important**

**Install Electronics in dry locations items such as intelabox, control head, relays, and optional modules.**



**NEVER** install in the following locations

Locations frequently subject to wet conditions

- Floor boards
- Inside doors
- Under K9 transporter
- Engine compartment
- Against the Air conditioner housing/vents
- Under seats
- Under cup holders of equipment consoles.
- Under the floor mats; this area is subject to excessive heat and moisture and may cause the unit to malfunction as well as shorten the life of electronic components. Do not install window module/relays inside of vapor barrier in door.

---

### **Ignition and Power Warnings**

***Careful Consideration should be made when connecting devices that could remove power to vehicle systems, alert features of this product or emergency warning systems that it activates.***



**Alarms, Auto Starters, Antitheft Devices** or any systems that shut off ignition power, **The K9 Heat Alarm power MUST be set up as “on all the time” (or “Car on manually off”)** The Hot-N-Pop Pro will need to be manually shut down when not in use.

**Do not remove factory gender specific quick disconnects. These connectors are designed for serviceability, prevent accidental damage, and allow for future upgrades.**

# Installation

## **STEP 1**

The install will vary greatly depending on the vehicle and its equipment.

Review the Hot-N-Pop® Pro Installation instructions including the **vehicle specific install supplement** to get an overview of the hardware placement, wiring and connections. Also review the Installation Information for each of the Heat Alarm Alert Options that you are installing. Make connections following the order outlined below. Consider where connections in following steps will be made. Planning will speed installation.

## **STEP 2**

### **Control Head installation**

Determine with the K9 Handler a suitable location for the Control Head to be mounted. The Head should be easily visible to the K9 handler. Plug the control head cable into the head.

Mount securely in a dry location inside the vehicle. Choose a location approved by the vehicle manufacture, see modifiers guide.

## **STEP 3**

### **Intelabox installation**

Find a location for the Intelabox, choose a DRY location where it is easily serviceable for upgrades;

**3A Attach the Intelabox Black Ground wire** to a good ground.

**3B Route the Control Head Cable** to the Intelabox. Attach the cable, be sure that the cables (RJ45) connectors go in straight and the cable is not kinked. Do not run control head cable parallel to transmitting antenna cables.



“TIP” When mounting behind trim panels, place the box temporarily in a location that allows easy connection of wires. Remember control head cable and stall sensor cables are 14’ long efficient routing of these cables should allow connection in many locations.

## **STEP 4**

### **Main Power**

Connect the Battery wire to an **uninterrupted** Battery connection point capable of supplying 40A of power. (Red wire from intelabox) The head will power up briefly and turn itself off.

## **STEP 5**

### **Connect options cable**

Connect the options cable to the 12 pin connector of the intelabox, the connector is keyed to plug in only one direction. Review the following steps and run the individual wires to their respective accessories and options.

#### **12 pin connector information**

Pin	Color	Option / Feature	Function	Polarity
1 & 2	Not Used			
3	Red	Ignition Power	Power	Positive
4	Yellow	Autostart	Optional	Negative
4	Yellow	No K9 Left Behind	No K9 Left Behind	Negative
5	Not Used			
6	Blue	Window feature	Timed	Negative
7	White (option)	No K9 Left Behind	Door Sense	
8	Black/Green	Fan option	Module Required	Negative
8	Black/Green	Pager option	Module Required	Negative
9	Green	Light feature	Latched	Negative
10	Orange	Horn feature	SOS pulse	Negative
11	Orange	Siren feature	SOS pulse	Negative
12	Orange	Spare	SOS pulse	Negative

A three pin “daisy chain connector is also provided for add on options.

# Installing K9 Heat Alarm® Pro alert features



Test current draw while installing alert features (Options) with an ammeter, by attaching between the appropriate trigger and ground. Note that blown fuse indicates problems; current draw may not exceed 300mA continues. Test all alert features prior to connecting options cable to intelabox. Options and Alerts triggers are ground [negative] triggered (see Chart).

## **STEP 6**

### **Horn Alert Feature**

#### **Horn ring connection**

Connect an orange wire from your options cable to the vehicles horn ring wire. **TEST: The vehicles horn wire will show power (12+ volts) when not active, when the horn pad is pressed it grounds this circuit (0 volts).**

-----  
If horn ring is not available an interface module is available to safely connect to the vehicles horn. See vehicle information supplement, or Contact Acek9.com.

## **STEP 7**

### **Siren Alert Feature**

Connect an orange options cable to the siren controller's remote negative input or horn ring input. ***Most siren manufactures web sights offer on line copies of their installation instructions. Never connect to siren speaker wire.***

## **STEP 8**

### **Lightbar / Strobe Alert Feature**

Programmed input method. When the light controller has a programmable input connect Green K9 options cable wire. The programmable input should be configured for negative activation of lights.

Traditional methods Lights activated buy a toggle switch\* or isolated outputs of a light controller are connected using the light activation module H-LAM-R by connecting as shown bellow. In this configuration the Red Wire is connected to the power wire coming into the siren controller, fuse appropriately to protect light Wiring. The White wire connects to the output wire of the lights that are being activated. The Green options cable wire is connected to Orange trigger of the H-LAM-R Module.

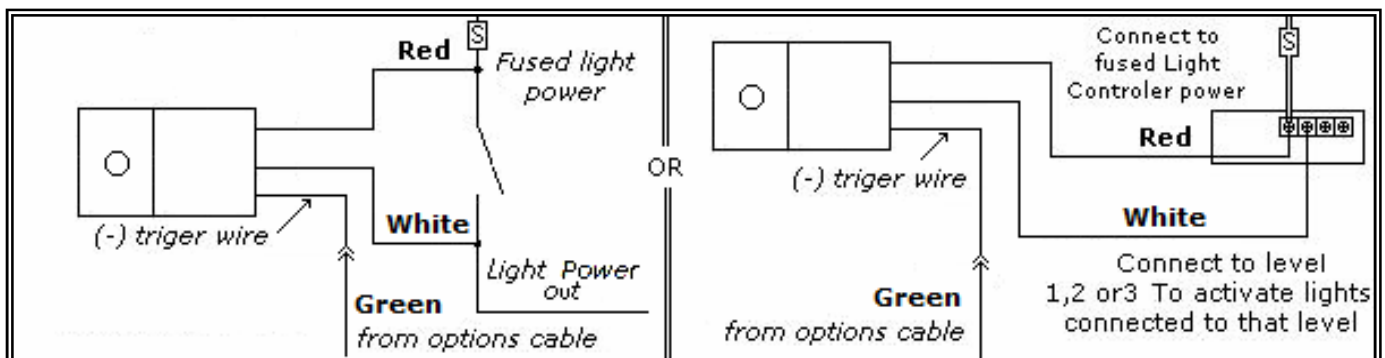

## **STEP 9**

### **Window Drop Feature**

**NEVER Place module in Wet Location Do not place in locations subject to wetness including floor boards, inside of vapor barrier in door, under K9 transporter, in the engine compartment, under seats and in center consoles under cup holders.**

Refer to Vehicle specific instructions and/or Instructions included with your window drop module. If Additional wire is added it should be large enough to handle the current. Connect Trigger wire to Window drop options cable Blue triggering wire.

## **STEP 10**

### **Temperature Sensors Mounting (H-TS22-K)**

**Never** place sensors where the K9 can damage the Sensors, behind trim, in direct sunlight, directly in front of air vent, near equipment that radiates heat, or within 8 inches of floor or headliner.

**DO NOT HEAT TEMPERTURE SENSORS WITH GUN OR FLAME TO TEST !**

The sensors should be set up to monitor the area where the K9 is housed.

**Sensor location may vary with vehicle setup and operation, The Temperature Sensor cables are 15 feet long so they can be adjusted to the most effective locations.**

Following examples are based the K9 being in a vehicle with K9 transporter behind the front seats.

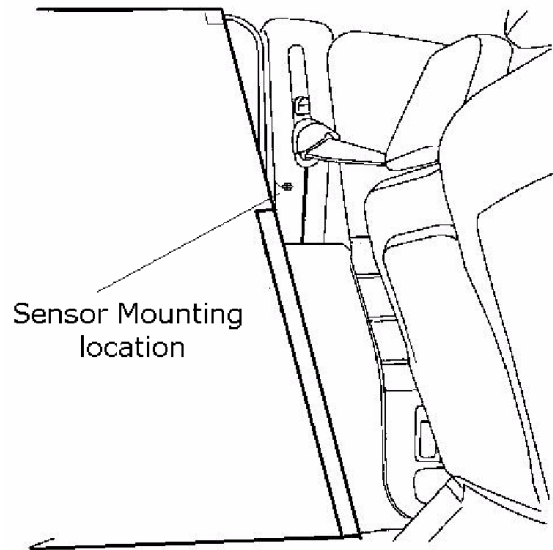

### **Sedans or Pick Up Trucks.**

Mount one Temperature Sensor midway up each pillar trim (on each side) in front of the K9 transporter, or in the airflow at front of the K9 transporter on each side.

**Sport Utility and Wagons.** Instruction is based on vehicles with K9 transporter behind the front seats. Mount one temperature sensor midway up pillar trim in front of the K9 Transporter and one on the pillar trim in back of the K9 Transporter, in good air flow. If area behind transporter is isolated from airflow the Sedan method may be more appropriate.

**Note: Averaging must be turned off if motioning 2 canines in separate climate controlled locations.**

## **STEP 11**

### **Heat Alarm ignition power (must be to ignition)**

From the Pro Series Option cable connect the Red Ignition wire to switched Ignition Power point on the Vehicle's fuse panel or the police package ignition wire. Ignition must be connected for proper operation of K9 Heat Alarm® Pro

## **STEP 12**

### **Stall Sensor Option (sold separately)**

The Stall sensor makes it easy to detect an Engine Stall. The Sensor detects the energy emanating from the Alternator to determine that the Engine is running. Mount the Stall sensor against the metal alternator housing, over its internal coils Route the Stall sensor wire through the Firewall to the Intelabox. If you have to drill a hole, use the supplied grommet, seal with silicone (not supplied). Cover the stall sensor cable with wire loom, **Avoid contact with moving parts and hot exhaust parts.**

**VERIFY that the stall sensor functions well after the vehicles battery is fully charged and under minimal load. Run vehicle. The LED on the Sensor is lighted red when the vehicle is stalled or not running.**

**“Tip” If the light is red when the vehicle is running it may need to be repositioned.**

## **Step 13**

### **Optional add on modules**

Connect any add on accessories purchased with system. See instructions included with accessory. Do not attempt to connect items not approved for use with this system. Use only Acek9.com accessories.

Additional input/outputs are provided for AceK9 Options. See the Installation Manual provided with each Option for details about installing that Option.

## **Step 14 Test Heat Alarm portion of the System**

## **Test Procedure**

### **System Test Procedure for K9 Heat Alarm of HP-5010**

**14-A Power.** The Default Power Settings is Heat Alarm ON with Ignition. When Ignition is turned ON, the Heat Alarm unit should power up.

**14-B System Status.** Observe the Feature Settings during power up. Then observe the Temperatures and Vehicle’s Battery Voltage. Confirm that the Displayed Temperatures are below the Heat Alarm Hot Set Point and the System in not in Snooze Mode.

\* **STALL SENSOR Note:** Due to the popularity of the Engine stall sensor factory default is enabled, if a stall sensor was not purchased the feature needs to be disabled in the menu.

**14-C System Output Test.** Press the MENU key (for a second) to review or change the Feature Settings or Power Settings. Use the arrow keys to scroll menu. The last Menu choice is System Test, Press OK to activate all the installed Heat Alarm Alert options. Verify that ALL the installed Heat Alarm Alert Options worked.

**14-D Test Temperature Sensors** By Turning the Vehicle’s Climate Control to the Heat position to manually raise the temperature inside the vehicle. Monitor the temperatures displayed on the heat alarm and confirm that the alarm activates when the Hot Set Point is reached. Return the Vehicles Climate Control to the Cool position. **DO NOT HEAT TEMPERATURE SENSORS WITH GUN OR FLAME TO TEST!**

#### **14-E Engine Stall Sensor Option Test**

Turn the Ignition to the ON position WITHOUT Starting the Engine  
Note that after the system completes the startup messages it beeps and displays the Engine Stall Alarm and alarm activates.

#### **14-F Test Heat Alarm Pro add on Accessories.**

**Refer to the Owner’s Manual(s) for the Operation and Testing**

## **K9 Door Popper® Installation**

### **STEP 15**

#### **Neutral Safety**

Attach the **Brown** Neutral Safety wire to the Vehicles Park Signal Wire or Transmission range sensor wire noted in the install Vehicle specific supplement\* The purpose of this wire is to detect when the Vehicle is in Park. Traditionally the Ignition Switch "Start" wire would provide a path to ground via the "PRNDL" Switch and the Start relay. The "PRNDL" Switch inhibits the engine from starting with the vehicle in gear. Many Vehicles utilize an "Anti-Theft" features or Computer controlled ignition systems requiring adaptor kits noted in the install Vehicle specific supplement.

**It is CRITICAL that the Brown Neutral Safety wire is attached to the vehicle wiring properly to allow the K9 Door Popper® features to prevent the door from popping when the vehicle is in gear and potentially moving. If this connection is not done correctly the canine could exit and be harmed while the vehicle is in motion.**

\* See Vehicle information supplement.

### **STEP 16**

#### **Antenna**

Mount the K9 Door Popper® Antenna and route the cable to the IntelBox. Keep Antenna as far away from other antennas as possible. See instruction included with antenna.

### **STEP 17**

#### **Door Preperation**

Always ask the Handler which door they would like to be remotely popped open. For safety reasons, the Passenger Side Rear Door is the best choice to avoid releasing the K9 into the flow of traffic.

Remove the Door Panel from the door that is going to be remotely opened.

Be Sure that linkages are secure and lock rods do not bind. If connecting to inside handle be sure that child safety lock is disabled.

### **STEP 18**

**Unlock & Solenoid Wires** Be careful to route the wires away from the window's travel and avoid sharp objects. Unlock connects to only the door that is popped.

**18A** From the intelabox Route the Solenoid power wire and also pull the ground into the door.

**18B** Connect solenoid ground to chassis. DO NOT GROUND SOLENOID TO DOOR the hinges make poor ground

**18C** Route the Unlock Motor cable to the b-pillar or into the door (check for vehicle specific information included in the new kit).

**18D** Locate the unlock motor wire using a voltmeter; this wire will go Positive during unlocking and ground at rest.

**18E** Cut this wire attach the cable's Yellow wire to the wire going to the Motor. Attach the Red wire to the wire coming from the switch/body control module.

### **STEP 19**

#### **Attach Popper Wires**

Attach unlock, neutral safety, and solenoid wires to the IntelBox.



## **STEP 20** **Solenoid Installation**

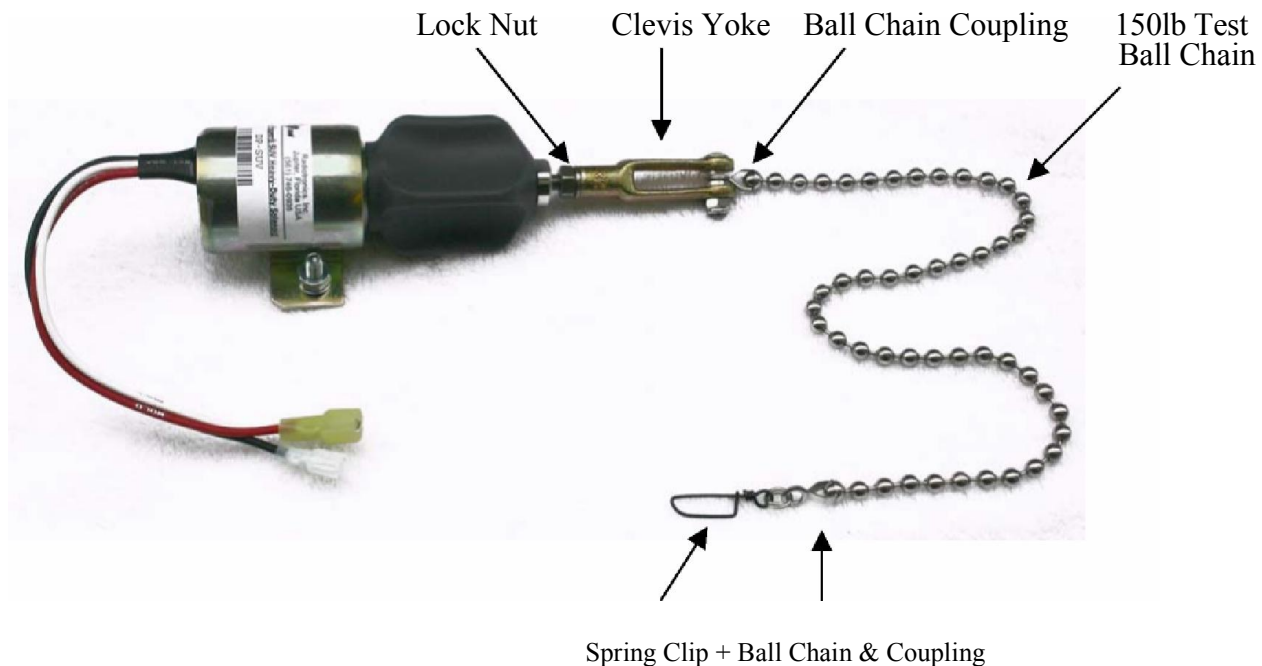

Obtain a good view of the door latch mechanism. Locate the lever on the door latch mechanism that if pulled will unlatch the door.

**Outside handle Connection.** Usually the lever that moves down when the outside door handle is pulled up. When attaching to a linkage use the Spring Clip to attach to the door latch lever. Place the Solenoid in the approximate area where it will be mounted. Detach the Ball Chain from the Ball Chain Coupling at the Solenoid or the Spring Clip and cut to the proper length.

**Inside handle connection** can be utilized if cable is used, many cables have ball or barrel ends that can connect directly to the ball chain coupling.

**Mount the solenoid** Determine a mounting location for the Solenoid that will allow it to pull the door latch lever in straight alignment, without ant interfere with the chain and other moving objects. Solder the solenoid and ground wires to the Solenoid wires, cover with heat shrink. Mount the solenoid to the door.

You can then make a fine adjustment of the Ball Chain tension by loosening the Lock Nut and turning the Clevis Yoke up or down the Solenoid threaded stud. The Heavy Duty Solenoid works best with some slack in the chain. When there is no tension on the door latch lever re-tighten the Lock Nut. Apply thread locker to lock nut and yoke.



### **DO NOT INSTALL THE DOOR PANEL AND CLOSE THE DOOR BEFORE THOROUGHLY TESTING**

Turn ON the Hot-N-Pop Pro. Verify that the Pop status light is on and not flashing (see Neutral safety information if flashing). Return to the open door with the K9 Door Popper® Remote. Without closing the door, use a tool to simulate the striker move tool into the door latch to closed, pull the tool back to simulate the door in the closed position. Press the Remote's button. If latch fails to release adjust the Solenoid. Lock the door and repeat the test. When you have confidence that the Solenoid is releasing the door latch mechanism close the door without replacing the door panel. Pull on the door to simulate the spring pushing on it and test again. When you are very confident that the Solenoid is working reliably, use cable ties to secure the Solenoid & unlock wires Re-install the door panel and Test again.

### **STEP 21 Gas Spring Mounting**

Mount door opening spring with rod pointing down at an angle. With the door fully opened and rest against its stops. Mount the brackets ¼" in from the springs fully extended position. The spring should allow the door to fully open without the spring being completely compressed or extended. See illustrations for approximate placement of brackets. When done correctly the door will open fully to allow an easy exit for the K9. Mount spring. Remove the door check to allow the door to open smoothly and quickly. Extreme Bracket angles may cause the spring to pop off.

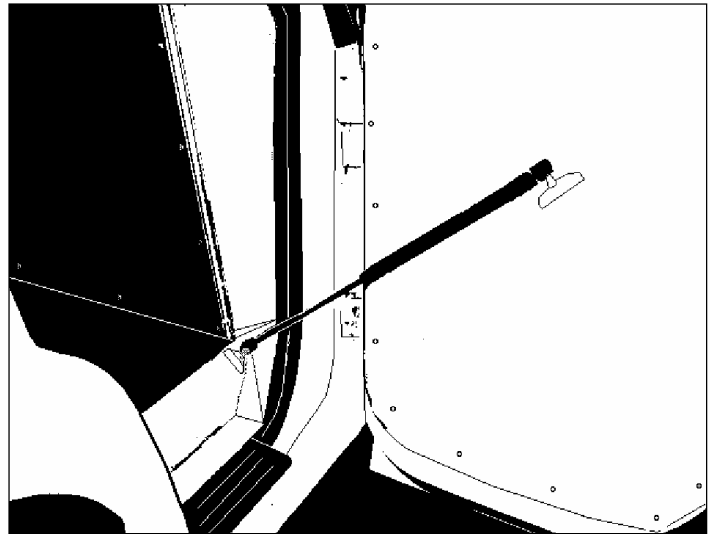

### **Step 22 Finish Install and Test System**

Recheck wiring placement, and connections. Secure cables and wires with cable ties. Install the intelabox in its appropriate location. Protect all connections, components that may be exposed to weather, Seal grommets. Completely test of the K9 Hop-N-Pop® Pro. Check the K9 Door Popper® with the Remote at a distance and from the Control Head. Confirm that the K9 Door Popper® is DISABLED and the door does not open when the vehicle is in gear. See test procedure.

**IMPORTANT: It is the responsibility of the Installer and the Handler to confirm that all safety features are installed and working properly at the time of installation. The handler is also responsible to make continuing periodic checks of all safety systems of this product.**

## **Test Procedure**

The Default Power Settings are Door Popper and heat Alarm are ON/Off with Car When Ignition is turned ON, the Heat Alarm and door popper will power up. Observe the pop status light.

### **K9 Door Popper Tests**

Put the Vehicle in PARK and Confirm that the Door Popper Status Light is ON, this indicates that Door Popper is READY.

Put the Vehicle in REVERSE and through ALL the DRIVE Gears, D-3-2-1 etc. and Confirm that the Door Popper Status Light FLASHES, this indicates that Door Popper is DISABLED. With the Vehicle in gear press BOTH the UP and DOWN keys simultaneously -or- press the button on the Remote and the Door should NOT Pop.

Put the Vehicle IN PARK, Press BOTH the UP and DOWN keys simultaneously -or- Press the button on the Remote and the Door should pop.

Verify that the door that is popping is unlocking. Note the other doors should remain locked to prevent unwanted entry into vehicle.

Test Door Popper Remote at a distance of 200 to 500 feet to confirm Remote's range.

Visually inspect the Gas Spring mounts and confirm they are not binding and that the door fully opens.

### **Repeat Heat Alarm test (Step 14)**

**If any of these tests fail please check the installation.  
Contact AceK9.Com Support with the Serial Number, Call 772-600-7574  
Be sure K9 handler receives a copy of the Owners Manual.**

## **Acek9.com Two (2) Year Limited Warranty**

For details visit <http://www.acek9.com>

### **Trouble Shooting**

#### **Communications Error no power to head**

- Check Control head cable for damage
- Check that connectors are fully inserted
- Check for corrosion or foreign material.
- Check that cable is not running parallel to transmitting antennas

#### **Heat Alarm Displays Snooze**

Alarm is in snooze mode. Start up snooze mode allows the K9 Handler time to start the vehicle, allow the temperature in the vehicle to reach a safe level, and resolve any alarm conditions. When the vehicle is running and the temperature is at a safe level the status light will turn on indicating monitoring of temperature. (see owners manual)

#### **Stall Sensor Alarm while driving or idling.**

Stall sensors adjustment is needed, check location of sensor it needs to be located over coils in the alternator (see install manual)

#### **Temperature Sensors Show Different Readings**

Sensors reading will vary with location and conditions. If it is necessary to prove the accuracy of the sensors by placing in exact same location, they will be within less than one degree of another.

Sensor reading differences are caused by the following. (See install manual for placement)

- Sun heating the car body
- Air conditioning flow
- Open windows or air leaks
- Placement of sensors

#### **No Door Popper Operation from Remote or Control Head.**

Pop Status Light Should Burn Steady in park, Blink When in gear. If Blinking the Neutral safety connection should be checked. (See Vehicle specific information).

#### **Door will not pop when activated, clicks are heard.**

Possible Causes

1. Solenoid is not grounded to chassis.
2. Door linkages are binding.
3. Unlock wires connected backwards or shorted. Check 10A Fuse at intelabox.
4. Solenoid needs adjustment.
5. Loose or broken electrical connection.



**ADJUSTMENT "Tip".** *If the solenoid bottoms out a loud "clack" will be heard indicating too much slack, adjust the yoke in or remove beads to remove slack. In retrospect too little slack will cause the solenoid not to release, in this case turn the yoke out to allow the solenoid to achieve the necessary momentum. If the solenoid is too tight the boot will pull out.*

Intelabox, Typically Located behind  
Glove Box or in Right side Kick Panel

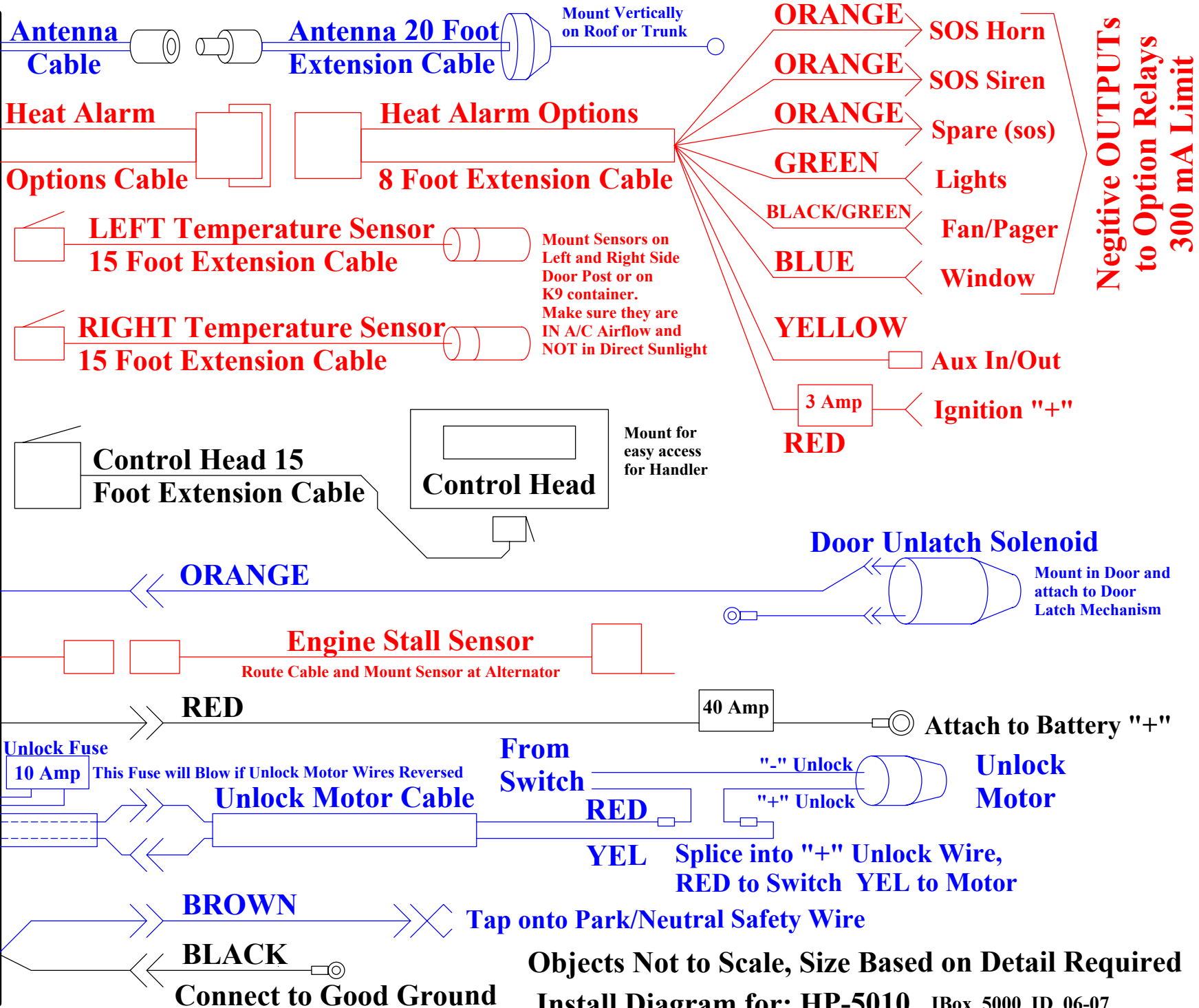

Objects Not to Scale, Size Based on Detail Required  
Install Diagram for: HP-5010 IBox\_5000\_ID\_06-07

# Hot-N-Pop<sup>®</sup> Pro IB-5000

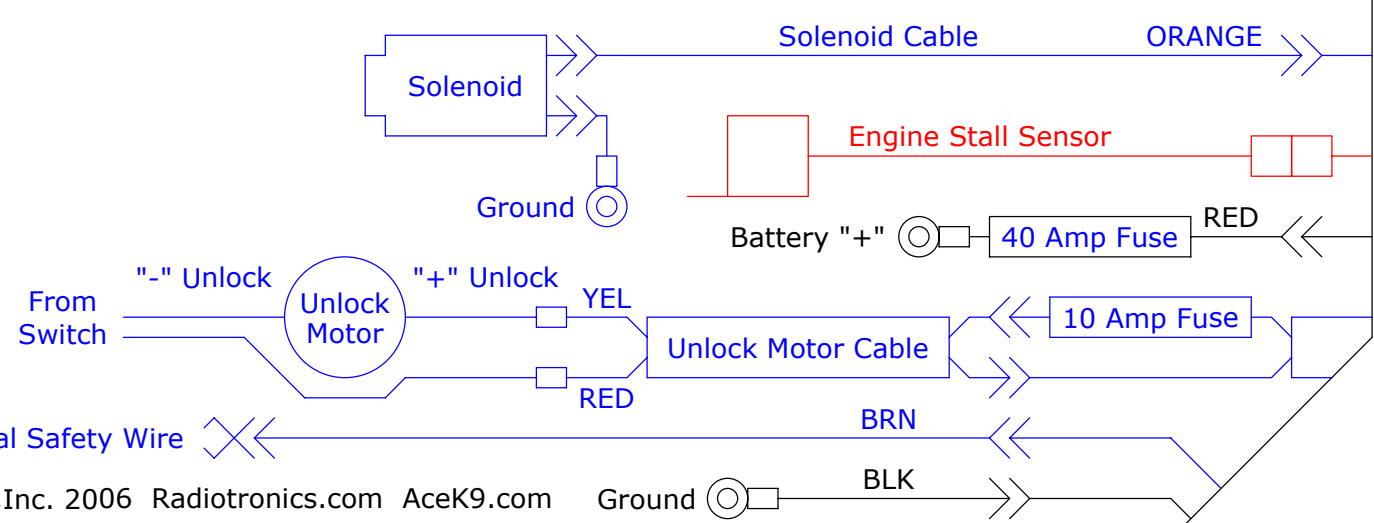
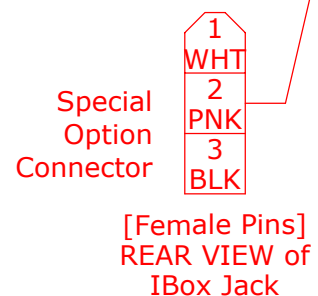
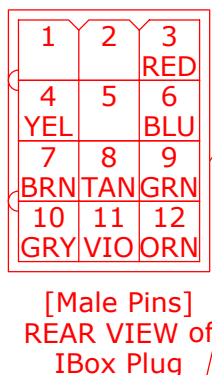
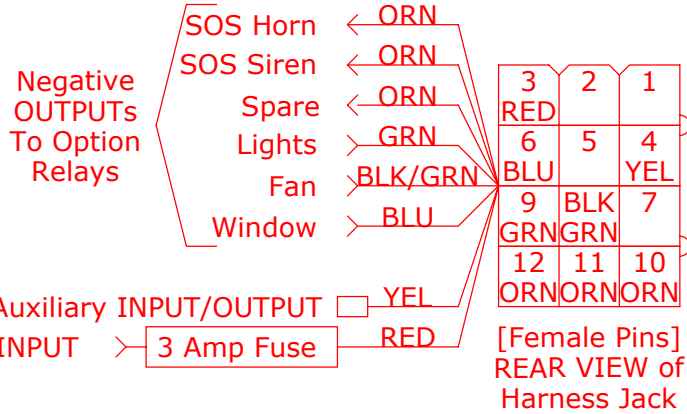
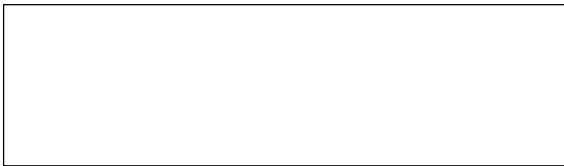

## Other Available Options



K-9 Cellular Communicator



10" and 12" Fan Kits



Heavy duty Fan Guard



Smoke Detector  
Auto Start Option  
Heavy Duty Fan Guard

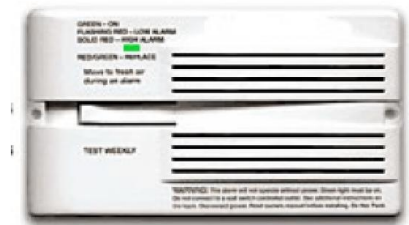

Carbon Monoxide Detector  
Anti-theft System

Visit [Acek9.com/store](http://Acek9.com/store)



(772) 600-7574

E-Mail [Service@AceK9.com](mailto:Service@AceK9.com)

Hours of operation Monday thru Friday  
8:00am to 4:30pm EST

All rights reserved. Radiotronics Inc.



A division of Radiotronics, Inc.

## Model HP-5010

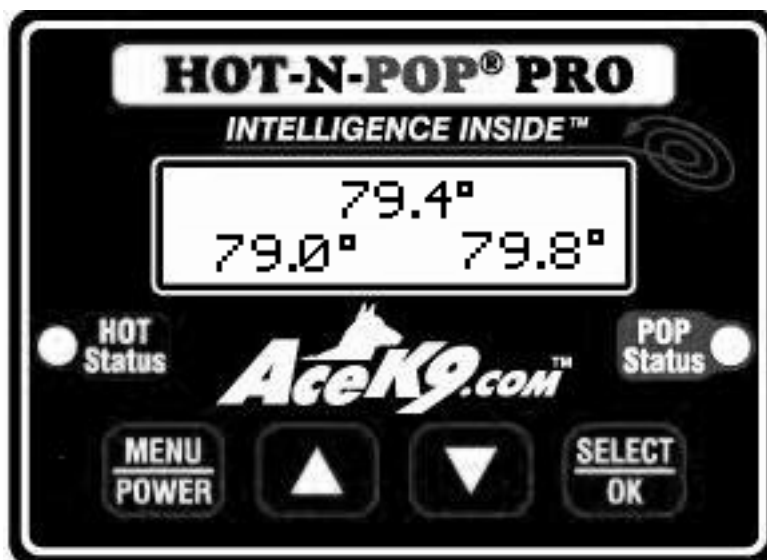

# Owners Manual

Operating Instructions



Radiotronics Inc.  
1315 SW Commerce Way  
Stuart FL 34997  
Phone: (772) 600-7574  
Fax (772) 600-7012

# Introduction

The Hot-N-Pop® Pro is a state of the art product designed and developed by the AceK9.com™ division of Radiotronics, Inc. It is a unique blend of positive features taken from actual field use of our K9 Heat Alarm® and K9 Door Popper® plus the incorporation of a microprocessor control system.

**Standard Monitoring Features:** The K9 Hot-N-Pop® Pro monitors the vehicle's interior Temperature and Battery Voltage. When the Alarm sounds, The Handler will be alerted by honking the Horn, rolling down both rear Windows\*, activating Emergency Lights, and Siren.

Additional options are Available

- ✓ Temperature Sensor Averaging – to reduce false alarms.
- ✓ Exclusive S.O.S Horn Honk™.
- ✓ Non-Volatile Memory – Temperature and other settings are maintained in memory when power is disconnected.
- ✓ Dual Window Drop. *\*Rear windows do not drop in cold alarm*
- ✓ Menu allows you to adjust settings to your needs.
- ✓ Temperature Sensors Monitor – Warns of damaged sensor and sets off Alarm if both Temperature Sensors are damaged. **Optional Monitoring features:**
  - E.S.M. Engine Stall Monitor™ – Alerts of Engine Stall BEFORE the vehicle's interior gets too hot or cold.
  - No K9 Left Behind - K9 removal reminder system
  - Smoke Detector
  - Carbon monoxide detector

**Door Popper features:** The K9 Door Popper® will enable you to release your canine to your aid when you are away from your vehicle.

- ✓ K9 Door Popper® Safety feature– When pressed for a second the door release Remote Unlocks and then Pops Open the Door.
- ✓ Door Popper Stopper™ – Extremely important Safety Feature that prevents the Door from opening when the vehicle is in motion.
- ✓ A Gas Spring – Quickly opens and holds the Door to allow the canine an unobstructed release.
- ✓ External Antenna – Enables long range reliability.
- ✓ Door Popper “On By Arming” Feature



## Overview

**Factory Default settings are based on the most commonly requested settings selected by K9 handlers. However you can customize them to your needs.** See menu choices section.

### Defaults

Hot-N-Pop® Pro Power:	On/Off with vehicle.
Door Popper Power:	On/Off with vehicle.
Hot Set Point:	90°
Cold Set Point:	Disabled
Stall Sensor	Enabled (Disable if not purchased)
Auto Snooze Mode:	Enabled
USA or Metric	Fahrenheit
Temperature Averaging	Enabled

**Dual Temperature Sensor Averaging™:** The individual temperature sensor readings are displayed along with the average temperature. This enables the Hot-N-Pop® Pro to obtain a much more accurate reading of the vehicles interior temperature. With averaging enabled, unnecessary false alarms are avoided when one of the temperature sSensors is in a warmer location. (Example: direct sunlight or open window). In order to activate the alarm, the AVERAGED (center) temperature sensor readings must reach the alarm threshold setting (90° Hot Default). As an additional safety measure the heat alarm is activated if either temperature sensors reading goes 10 degrees above the threshold setting.

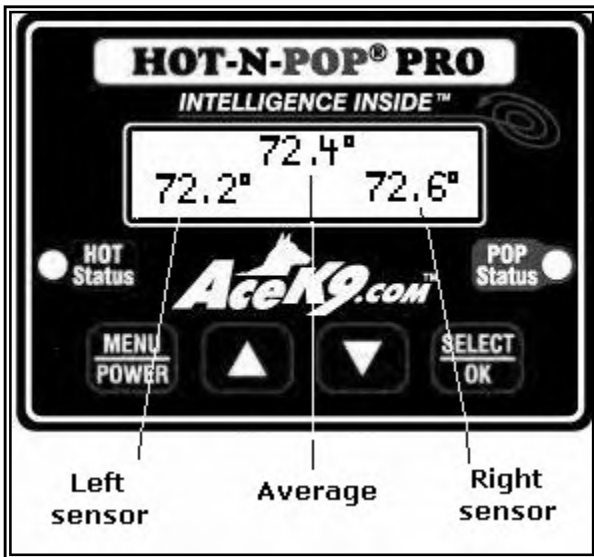

Disable Temperature averaging if monitoring two separated locations. To change see the Menu choices section.

# Operation

**IMPORTANT safety reminder:** It is the responsibility of the Installer and the Handler to confirm that all safety features are installed and working properly at the time of installation.

**Setting are customizable to your working environment.**  
**See changing settings section if manual.**

**Heat Alarm Power:** The Heat alarm will turn on with the ignition. When the ignition is powered off the heat alarm will power down. This requires you to leave the vehicle running with the air conditioner ON to maintain a safe environment for the canine, and remove the K9 if the vehicle is off.

### **Alternative settings**

*If your environment allows for the canine to be left in the vehicle with the ignition off, The setting should be changed to ON/Off manually, On with Car and OFF manually, or No K9 Left Behind (optional hardware required).*

**Door Popper Power:** The Door Popper will turn on and off with the ignition. To enable door popper with vehicle off use Alternative setting "On with vehicle and OFF manually" or On By Arming are available.

**Standard Operation:** The Left, average, and right Temperatures are displayed in the primary screen; the Vehicle's Battery Voltage is displayed periodically. When the Hot-N-Pop® Pro has detected safe conditions the HOT status light will illuminate, indicating that temperature is being monitored. The POP Status Light will illuminate indicating that the door popper is ok to pop.

**Snooze Mode:** At start up, Snooze Mode will automatically appear if there is an over temperature or another condition that requires attention. A Snooze period of approximately 10 minutes allows time to get the vehicle running and cooled down for the safety of your K9. When the Hot-N-Pop® Pro does not detect a safe condition at the end of the snooze period the Pre Alert alarm will activate. Snooze can be manually reactivated (By pressing OK). Only 3 snooze periods are allowed.

**Note:** During Snooze, the Handler is responsible to monitor the conditions of the canine.

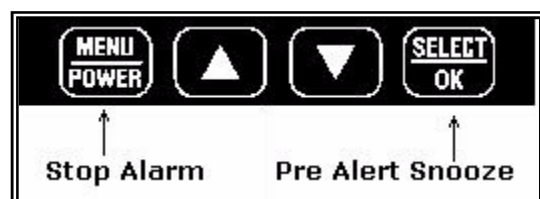

## K9 Door Popper®

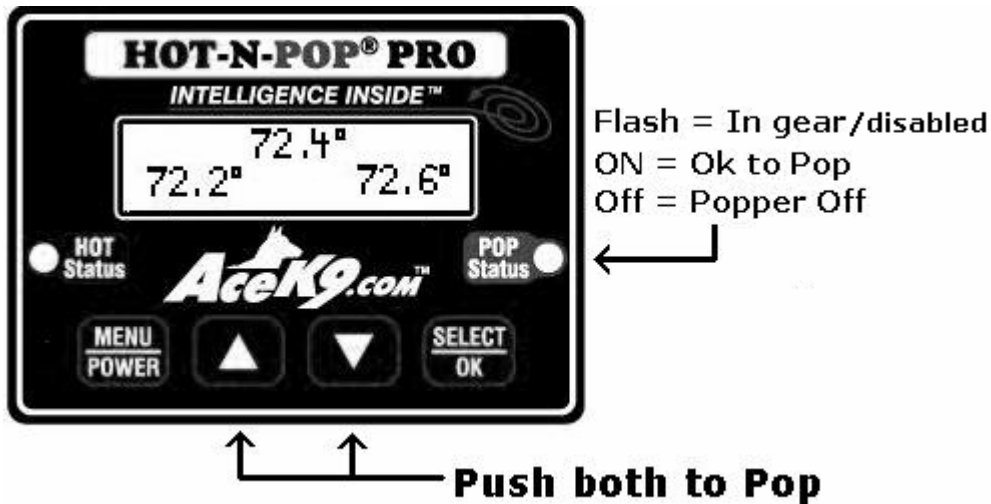

**Activate the K9 Door Popper®** by pressing the button on the Remote Control Transmitter, or from the Hot-N-Pop® Pro Control Head by pressing BOTH the ▲ and ▼ keys simultaneously. When the door popper is activated the door being popped is unlocked, followed by the latch releasing to open the door. Note the latch is released 2 times in case of obstruction to the door or latch. *Note: if on by arming is selected* pressing the [OK] Button Arms the door popper until the vehicle is put in gear again.

### **Popper Remote**

Always place the Remote Control Transmitter in a safe and accessible location it is very small and easy to wear on a belt or conceal in another location.

### **Battery Replacement** P# GL22-23A

Remember to replace the Door Popper Remote Transmitter Battery if you notice a decrease in range while conducting the weekly test. To replace the battery remove the Phillips screw on the back of the remote. A replacement Battery can be located at your local electronic store or by ordering one from AceK9.com.

# Alarm Modes

**Pre-Alert Mode.** During Pre-Alert a description of the unsafe condition will Display, along with flashing light and warning tone for 40 seconds. This allows the K9 Handler to put the unit into Snooze Mode or turn Off the K9 Heat Alarm® Feature before the Full Alarm is activated.

**“FULL ALARM” Mode** During full alarm all installed Alert Features are activated. The Hot-N-Pop® Pro will continue the Full Alert Alarm Mode until the temperature or other condition in the vehicle returns to a safe condition or until the [MENU] key is pressed. If a safe condition is detected by the system; the Full Alert Alarm Stops and the Display shows a Reminder Note to advise the K9 Handler that an alarm has occurred.

**Clearing reminder:** To clear the Alarm Reminder, Press [OK] while the reminder is being displayed. **Reminders will also clear when the unit is restarted.**

**Temperature Alarm:** When an averaged temperature that is above hot set point or below a selected Cold Set Point is sensed Hot-N-Pop® Pro goes into Pre Alert. If no action is taken and it remains so the unit will go into full alarm.

**Engine Stall Monitor™Option** (Purchased separately): With the stall sensor option installed and enabled in software, the Hot-N-Pop® Pro will monitor the engine. When the engine stalls “Engine Stalled/Pre-Alert Mode” is displayed allowing the K9 Handler to Restart the Engine or Snooze. If no action is taken the Full Alarm is activated.

**Vehicle Battery Sentinel™:** The vehicle’s Battery is monitored and the Voltage is periodically displayed. The Battery Sentinel sets the alarm off before the battery dies. Battery Voltage below 10.5 Volts (default) will display a warning and the unit enters Low Voltage mode. The Full Alarm is activated for a short period of time lowering rear Windows providing ventilation for the K9. The Alarm will activate again every few minutes as long as there is enough battery power.

**Temperature Sensors Diagnostics:** The Temperature Sensors are continuously monitored; if one of the Sensors is damaged or a connection is lost, the Hot-N-Pop Pro will automatically disable Averaging and utilize the working sensor. Periodically a warning message and beep will occur to notify the handler. If both Temperature Sensors are damaged, the warning message is Displayed, Pre alert starts, followed by Full Alarm activating.

## Alarm Modes continued

**Self Diagnostics:** The Hot-N-Pop Pro continuously monitors its internal systems. If a detectable problem exists that would prevent the system from operating properly the system will go into Full Alarm mode.

---

**\*\*\* It is important to remember that, while every effort to monitor the system is taken, there is no substitute for doing the Weekly tests outlined in this manual. \*\*\***

---

## Changing Settings



### **Light Intensity adjustment.**

The light intensity is controlled by using the arrow keys. The lights automatically dim, when the vehicle's ignition is turned OFF (press the OK key to return it to the original intensity).

**Menu Mode:** To enter menu mode, power up the Hot-N-Pop® Pro, then press the [MENU/POWER] key. To view Menu items Press the [Down] key for the next item or the [UP] key for the previous item. To change a Menu item press the [OK] key. The [DOWN] and [UP] Keys let you scroll through the available settings. To choose a setting, press the [OK] key. To exit without making changes press the [MENU] key. In Menu additional changes can be made or exit the menu by pressing the [MENU] key again. When returning from the Menu Mode, the system will enter into the selected operating configuration.

## Menu Choices

### **Door Popper Power**

*Default setting is "On/Off with CAR", Turning on and off with ignition (Traditionally the key)*

*Alternative Setting: "Off" all the time.*

*Alternative Setting: "On/Off Manually" so that even if the vehicle is not on the Door can be popped to let the canine out.\**

*Alternative Setting: "On By Arming" This feature Arms the door popper by pressing the [OK] Button. The door popper will arm when the vehicle is put in park. See the On By Arming Supplement for details.\**

*\* When in these modes turn off door popper manually to prevent battery drain.*

### **Heat Alarm Power**

*Default setting is "On/Off with Car" This will turn the Heat Alarm ON & OFF with vehicles ignition, most commonly the Engine and A/C are usually left ON to maintain the vehicle's interior temperature. Remove the K9 if the vehicle is off.*

*Alternative Setting "Car on Manual off" The Heat Alarm will turn ON with ignition and OFF by Keypad. This is the safest method. The unit will automatically turn ON with the vehicle but will only turn OFF when you depress and hold the menu key.*

*Alternative Setting "On/Off Manually" The Heat Alarm will only turn ON or OFF with Keypad.*

*Alternative Setting "Off all the Time" The Heat Alarm feature is disabled requires re-enabling through the Heat Alarm Power Menu.*

*Alternative Setting "No K9 left behind" the Heat alarm will turn on with ignition and off when ignition power is off and the Door is opened to remove the K9. See user supplement sent with this option*

*(Sold separately)*

### **"Heat Alarm Temp" Hot Set Point**

*Default setting is 90° to activate the Heat Alarm but can be adjusted from 77° to 95° as your needs require.(24°C to 32°C)*

### **"Cold Alarm Temp" Cold Set Point**

*Default setting "disabled". The cold Alarm but can be set between 10° to 58° as your needs require.(-12°C to 12°C)*

**Stall Monitor** *Default setting is "Enabled". When an optional stall sensor is not purchased this feature should be disabled.*

**Temperature Averaging** *Default setting is "enabled" so the Temperatures of the Dual Temperature Sensors are AVERAGED thus reducing false alarms.*

*Alternative Setting: Disabled This setting would be used if monitoring two separate locations in one vehicle (example on K9 in the bed of a pickup, and one in passenger compartment)*

## Menu choices continued

**Auto Snooze Mode** *Default setting is "enabled"*. Auto Snooze Mode temporarily disables the Heat Alarm to allow time for the vehicle to cool down during start up.

*Alternative Setting: Disabled*

**USA or Metric** *Default setting is Fahrenheit (USA)*

*Alternative Setting is Celsius*

**Previous Alarms** Displays the five previous causes of the Alarms.

**Serial Numbers** Displays the Serial Numbers of the Control Head and the IntelBox. See Additional information in back of manual.

**Reset to Default** Resets all features to their respective Factory Default settings.

**System Test** Pressing [OK] will begin a System Full Alert Test activating the window drop, SOS Horn, Lights, and Siren. Accessories such as Pager, K9 Cellular Communicator™, fan, and Radio Voice Module will also activate. Followed by a Pixel test, that will fill all the pixels in the display, both top and bottom. Ending with a Push button test will allow testing of each of the Menu Keys. If any of these tests fail contact your installer or AceK9.com for further assistance.

## Testing of Add on Options

See the test procedure outlined in the options manual.

Popular add on Options

- Stall Sensor
- No K9 left behind
- Fan Kit
- Pager Module
- Cellular communicator

Visit [www.AceK9.com](http://www.AceK9.com) for more options available.

**AceK9.com Two (2) Year Limited Warranty**

For details visit <http://www.AceK9.com/Warranty>

# **Weekly System Test Procedure for Hot-N-Pop® Pro**

K9 should not be in the vehicle during these Tests.

Turn the system on, Observe the Feature Settings during power up, Check the Temperatures and Vehicle's Battery Voltage.

## **K9 Heat Alarm Output Tests**

Confirm that the Displayed Temperatures are below the Heat Alarm Hot Set Point and the System is not in Snooze Mode. Press the MENU key to enter menu mode. Move down to the menu choice "System Test", Press OK to activate all the installed Heat Alarm Alert options. Verify that ALL the installed Heat Alarm Alert accessories and options worked.

## **Temperature Sensors Test**

Turn the Vehicle's Climate Control to the Heat position to manually raise the temperature inside the vehicle. Monitor the temperatures displayed on the heat alarm and confirm that the alarm activates when the Hot Set Point is reached. Visually inspect the wiring and electronic components and confirm that the location of the Temperature Sensors is just outside the K9 container and not in direct sunlight.

## **K9 Door Popper Tests**

Put the Vehicle in PARK and Confirm that the Door Popper Status Light is ON, this indicates that Door Popper is READY. Put the Vehicle in REVERSE and through ALL the DRIVE Gears and Confirm that the Door Popper Status Light FLASHES, this indicates that Door Popper is DISABLED. Lock Doors. Now press the UP and DOWN keys simultaneously -or- press the button on the Remote and the Door should NOT Pop. Put the Vehicle IN PARK, Press BOTH the UP and DOWN keys simultaneously -or- Press the button on the Remote and the Door should pop.

**IF THE ABOVE TEST FAILS – TURN OFF Door Popper until system is repaired and all tests pass!** Test Door Popper Remote at a distance of 200 to 500 feet to confirm Remote's range. Visually inspect the Gas Shock mounts and confirm they are not binding and that the door fully opens.







Radiotronics, Inc.  
1315 SW Commerce Way  
Stuart FL 34997-7231  
Ph 561-746-0935  
[www.AceK9.com](http://www.AceK9.com)

All rights Reserved, Radiotronics Inc 2013